

sTMS mini

Instructions for Use

sTMS mini Patient Manual



Caution: Federal law (U.S.) restricts this device to sale by or on the order of a physician.

Table of Contents

Before You Begin	3
Intended Use	4
Warnings and Precautions	4
Contraindications	6
Clinical Trial and Adverse Reactions.....	8
Your sTMS mini.....	8
Getting to Know Your Device.....	9
Using Your Device	11
Setting Up the Device.....	11
Recommended Treatment	11
Preparing for Treatment	12
Positioning the Device.....	14
Delivering the Treatment	14
Renewing Your Prescription	15
Replacing the Micro SIM Rx card.....	15
Additional Information	16
Caring For Your sTMS mini.....	17
Understanding System Display Messages	18
Troubleshooting	19
Service	20
Return Goods Policy	20
Technical Specifications.....	20
Operating Environment.....	21
Storage Environment.....	21
Industry Standard Classification	21
REACH and Warning Statement	22
EMC Compliance and Warning Statement.....	22
EMC Guidance	23
Glossary of Abbreviations.....	26
Medical Device Reporting.....	27
Warranty and Limitation of Liability.....	27
Customer Care Contact Information	27

Before You Begin

Thank you for choosing the eNeura sTMS mini, the portable single-pulse Transcranial Magnetic Stimulation (sTMS) device. This manual provides the Information you need to use the sTMS mini. You will see cautions, warnings, and helpful information placed near the related steps. Call Customer Care if you don't understand something in this manual.

eNeura and your doctor are committed to helping you manage your migraine pain. The sTMS mini is a new, safe, non-drug therapy to treat migraine at the first sign of pain.

Please read this entire manual before using the sTMS mini. Learn the contraindications, cautions, warnings and notes about the use of the device. As the manufacturer, eNeura cannot and does not intend to give medical advice. Contact your doctor for all medical advice. This manual should be kept near the sTMS mini and be available at all times.

eNeura is committed to the service and support of our customers. If there are any questions about the use of the eNeura sTMS mini, please contact Customer Care or your local representative at the following:



Manufactured by: eNeura Inc.
715 North Pastoria Avenue
Sunnyvale, CA 94085

eNeura Inc.
715 North Pastoria Avenue
Sunnyvale, CA 94085
Tel: +1 408.245.6400
Toll free (USA only): +1 855.366.8355
Fax: +1 877.874.9584
www.eNeura.com
info@eNeura.com
customer care@eNeura.com

eNeura (UK) Ltd.
6th Floor
One London Wall London EC2Y 5EB
United Kingdom
www.eNeura.co.uk
Tel. +44 (0) 20.3695.4063
Fax: +44 (0) 20.7785.8152
customer care@eneura.co.uk

Authorized Representative

Emergo Europe BV
Prinsessegracht 20
2514 AP The Hague
The Netherlands
Tel: +31 (0) 70.345.8570
Fax: +31 (0) 70.346.7299
www.emergoeurope.eu

Australia Sponsor

Emergo Australia
Level 20, Tower II, Darling Park
201 Sussex Street
Sydney, NSW 2000
Australia
www.emergogroup.com

Intended Use

The sTMS mini (The System) is indicated for the acute and prophylactic treatment of migraine headache.

The System is designed for self-treatment and delivers a non-invasive, brief, single pulse of magnetic energy to the back of the head. This creates a brief electrical current in the brain intended to stop or reduce the effects of migraine headaches. This type of stimulation is called single-pulse Transcranial Magnetic Stimulation or sTMS.

The System is a drug-free treatment option that can be used in the home or away from home based on your doctor's instructions. After treatment, there are no restrictions. You can resume your normal activities.

- ▲ **WARNING:** This device should be used under the supervision of a physician.
- ▲ Keep the sTMS mini out of the reach of children.
- ▲ Safety and effectiveness have not been established in pregnant women, children under the age of 18 and adults over the age of 65.
- ▲ The long-term effects of single-pulse transcranial magnetic stimulation are unknown.

Warnings and Precautions

The words ▲ **WARNING**, **Precaution** and **NOTE** have special meanings in this manual. Read them throughout the manual to ensure the safe and effective use of your sTMS mini.

▲ **WARNING:** A ▲ **WARNING** tells you that the personal safety of the patient may be involved. Ignoring a **WARNING** could result in injury to the patient. **WARNINGS** in the manual are shown in an orange box.

Precaution: A **Precaution** means that exact steps must be followed to prevent damage to the product. **Precautions** in the manual are shown in a purple box.

NOTE: A **NOTE** gives special information to ease product use or to explain important information. **NOTES** in the manual are shown in a dashed box.

- ▲ **WARNING:** The sTMS mini should be used under the continued supervision of a physician. The System has been prescribed by your physician only for you.
- ▲ Inspect the System for any signs of damage before use. Do not use it if it is cracked or wet. If you suspect damage to the device, call eNeura at: +1 855.366.8355 option 1 for assistance.
- ▲ Do not operate the System in or near an area where explosive gases are being used or have been used. Do not operate near gasoline or natural gas.
- ▲ Do not operate the System in or near the presence of a FLAMMABLE ANESTHETIC MIXTURE WITH AIR or WITH OXYGEN or NITROUS OXIDE.
- ▲ Risk of electrical shock. Do not open the System. There are no parts that can be serviced or replaced by the user. High voltage may be present.
- ▲ Risk of electrical shock. Do not allow the System or power cords to get wet. Quickly wipe up spills on or near the sTMS mini. Do not use the System in or near water. For example, do not use while in the bathtub or shower, in the rain, or while standing in water or on a wet surface.
- ▲ Do not use the System if the cause of your headache is illness, underlying pathology, trauma or overuse of medication. See your physician if you are uncertain.
- ▲ Do not use the System if you have suspected or diagnosed epilepsy or a personal or family history of seizures. Consult your physician before using the System if a family member has epilepsy or seizures or if you have had seizures, a head trauma or head injury or take any medication such as tricyclic antidepressants, neuroleptic agents, or other drugs that lower the seizure threshold.
- ▲ Do not use the System if you have a history of stroke.
- ▲ The device is only intended for use when you experience the onset of pain associated with a migraine headache with aura. The device has not been shown to be effective when treating during the aura phase before onset of pain.
- ▲ The System has not been demonstrated as safe or effective when treating cluster headache.
- ▲ Do not use the System if you use a wearable cardioverter defibrillator (WCD).
- ▲ The long-term effects of chronic magnetic stimulation are unknown.
- ▲ Transcranial magnetic stimulation should only be applied to the back of the head as described in the "Using Your Device" section of this manual.
- ▲ Do not stimulate over the front of the neck or mouth. Severe spasm of the laryngeal and pharyngeal muscles may occur and the contractions may be strong enough to close the airway or cause difficulty in breathing.
- ▲ Do not stimulate over the upper side of the neck. Stimulation of the carotid sinus nerves, particularly in patients with a known sensitivity to the carotid sinus reflex, could result in a sudden drop in blood pressure, slowing of the heart or loss of consciousness.
- ▲ Do not stimulate the chest or back. The induction of electrical current into the heart may cause cardiac arrhythmias.

Contraindications

▲ WARNING: Failure to follow the restrictions listed below could result in serious injury or death.

The sTMS mini creates a very strong single-pulse magnetic field. The System has been prescribed by your doctor for your use only. The System may not be used in patients who have metals, conductive materials, or metal-containing implants in their head, neck or upper body. Metals and conductive materials can be affected by a magnetic field. You should discuss this with your doctor before use.

Do not use the System if you have a cardiac pacemaker, vagus stimulator (VNS) or other implanted neurostimulator, implanted cardioverter defibrillator (ICD) or any implanted medical device that stimulates the body or uses any signal from the body.

Talk to your doctor before using the System if you receive an implant. Patients with implants affected by a magnetic field should not use the System. Examples of such implants include:

- Aneurysm clips or coils
- Cochlear implants
- Cerebral spinal fluid shunts
- Bullets or pellets lodged in the head or upper body
- Metal plates, screws, staples or sutures in skull, neck, shoulders, arms or hands
- Radioactive seeds
- Magnetically programmable shunt valves
- Stents
- Filters
- Metallic artificial heart valves
- Facial tattoos with metallic ink
- Electrodes

Dental implants, fillings or other dental appliances are okay and are not affected by the device.

NOTE: If you have an implanted medical device but are not sure if it has metals or conductive materials, please talk to your doctor before using the sTMS mini.

- ▲ **WARNING:** The System should not be used while driving, operating machinery or during any activity in which involuntary muscle contractions may put the user at risk of injury.
- ▲ Stay at least **2 feet (0.6 meter)** from others when using the System. The System could be harmful to anyone with an electronic implant such as a pacemaker. Anyone with a hearing aid or cochlear implant may hear an audible click.
- ▲ The device could be disrupted by RF-emitting equipment including: wireless home network devices, mobile phones, cordless telephones and their base stations and walkie-talkies. See “EMC Compliance and Warning Statement” section for additional information on preventing unwanted interference.

- **Precaution:** Keep the System away from other electronic devices that depend-on (receive) or radiate (transmit) radio frequency energy, when it is powered on.
- The operation of the System may be impaired when operated near home devices such as wireless network routers, mobile phones, cordless telephones and their base stations and walkie-talkies. Keep the sTMS mini device at least **2 feet (0.6 meter)** from these devices when it is powered on and in use.
- Keep credit cards, audio/video tapes, computers, computer disks, flash memory sticks, cell phones, personal digital assistants (PDAs), MP3 players, headphones, digital cameras, portable glucose meters and other electronic devices or electronic storage media more than **2 feet (0.6 meter)** away from the System when it is in use.
- Keep any loose metal objects such as eyeglasses, keys, coins, jewelry, watches and hair clips more than **2 feet (0.6 meter)** away from the System when it is in use.
- Keep wearable medical devices such as insulin pumps, medicinal pumps, monitors, bone grow stimulators and Transcutaneous Electrical Nerve Stimulator (TENS) devices more than **2 feet (0.6 meter)** away from the System when it is in use.
- Safety and effectiveness have not been established in pregnant women, children under the age of 18 and adults over the age of 65.
- Caution should be used for patients with suspected or diagnosed heart problems.
- The System is only intended to be serviced or maintained by the manufacturer. Do not attempt to open the device. The warranty may be invalidated. If the device is opened, contact eNeura at: +1 855.366.8355 option 1.
- Keep the System out of the reach of children.
- Side effects can include minor dizziness, nausea, vomiting, application site tenderness, muscle spasm, headache and migraine.
- Special precautions regarding Electromagnetic Compatibility (EMC) are required when installing and using the System. Portable and mobile communications devices can affect proper operation of the System. See “EMC Compliance and Warning Statement” section of the Instructions for Use for more information.

Clinical Trial and Adverse Reactions

eNeura completed a clinical study in Headache Centers in the United States designed to support safety and effectiveness for use of the Spring TMS device, an earlier design of the sTMS mini, for the acute treatment and prophylaxis of migraine headache. Baseline medication and symptoms were recorded for 28 days via patient diary. Subjects were instructed to use the SpringTMS device daily (morning and evening) and for the acute treatment of attacks for three months with no change in preventive medication. Study results showed statistically significant reduction in migraine headache days of 2.8 days from a baseline mean of 9.1 days. Forty-six percent of the patients saw at least a 50% reduction in headache days (responder rate). Reduction in acute medication was 2.9 days. A statistically significant improvement in quality of life was reported.

For further information about the clinical trial and any adverse reaction, please contact eNeura at 1-855-366-8355, option 1 or consult your prescribing physician.

Your sTMS mini

The complete sTMS mini includes this manual and the following items:

The battery-powered, rechargeable device

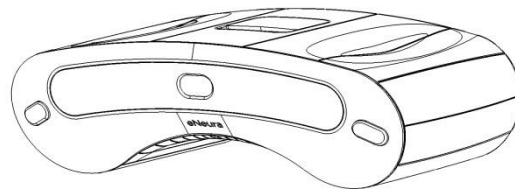

Prescription card with SIM (Subscriber Identity Module) Rx card

NOTE: Your first Micro SIM Rx card has been preinstalled



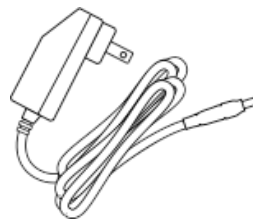

Battery Charger 12V DC 1.5A 18 watts
(reorder no. DWG-0505)



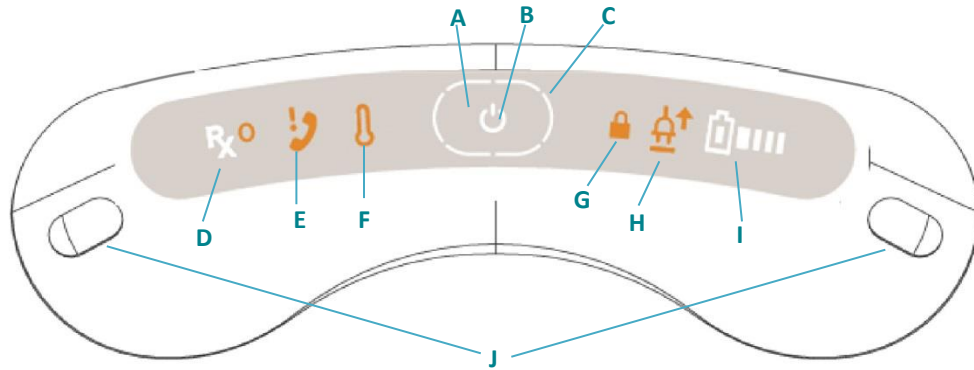

Getting to Know Your Device



A. Power Button  In the center of the panel on the top of the System. Press the power button to turn the device on and off.

B. Power Indicator  LED light on the top of the System inside the Power button. Static white illumination shows the device is on and ready.

C. Treatment Progress Indicator  LED light around the power button on the top of the System, shows status as it prepares for treatment.

D. Prescription Status Indicator  Located on left side on the top of the System. Confirms a valid Micro SIM Rx card is installed and shows the status of the prescription programmed on the Micro SIM Rx card.

E. Contact eNeura Customer Care  Action required.

F. Temperature warning  The device temperature is not in range for safe use.

G. Lock Indicator  On the right of the Power button. Indicator is visible when device is turned on if the security lock switch is enabled.

H. AC Adapter  On the right of the Power button. Indicator is lit when the AC adapter is connected to the device.

I. Battery Capacity  On right side on the top of the System. Indicates whether or not battery power is enough to allow treatment.

J. Treatment Buttons On the right and left edge of the panel on the top of the device. Press one or both buttons to deliver a treatment.

Read “Understanding System Display Messages” for more information.

Battery Charger (Power Supply) and Micro SIM Rx card Ports

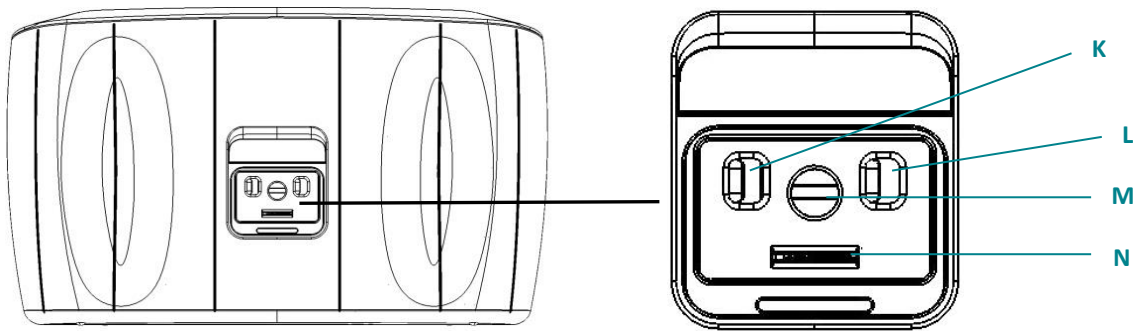

Door side of device, with door open

K. Lock ON/OFF Switch – Located behind accessory port door, on the left. Slide the switch to the left or right to unlock or lock the device

L. Volume ON/OFF Switch – Located behind accessory port door, on the right. Slide the left or right to turn the sound on or off

M. Battery Charger Port – Located behind accessory port door, in the center. Recharge the batteries by plugging the AC battery charger, DWG-0505, into this port

AC battery charger 12V DC
1.5A 18 watts
(reorder no. DWG-0505)

Plug that connects to
the System

N. Micro SIM Rx card port – Located on the back of the System beneath the Accessory Door. Insert the micro SIM RX card into this port.

- **Precaution:** Use only eNeura-supplied accessories with your System: Battery charger (reorder no. DWG-0505) and Micro SIM Rx card.

Using Your Device

- **Precaution:** Prior to use of the System, this manual must be completely read and understood. Improper use may cause personal injury and damage to the System and may void the warranty.
- You, as the user of the System, must become familiar with the functions and features of the device prior to use.

Setting Up the Device

Be prepared to treat your migraine when needed. Set up your sTMS mini as soon as it arrives and keep your device charged and ready to treat.

NOTE: Use only as directed. The device should only be used per the instructions of your physician who prescribed the System.

- Remove the System and the battery charger from the box.

NOTE: Do not discard box or packing materials. They will be required if you need to return this product.

- Your device should arrive ready to use. If it is not ready, plug the battery charger into a standard wall outlet. Connect the other end of the battery charger to the port on the device. Charge the battery for about 4 to 6 hours.
- Treatment delivery is not available during battery charging.
- If the device is on while charging, the AC adapter symbol and the battery capacity symbol will be lit.
- Unplug the battery charger when the device is fully charged. A fully charged battery should deliver at least 12 treatments.
- Keep the accessory door closed when not in use.
- Store the device and its battery charger in a cool, dry place, away from excessive dust and direct sunlight.

- **Precaution:** Only use the battery charger (DWG-0505) included with the sTMS mini. Contact eNeura if you have any questions.

Recommended Treatment

The treatment with the sTMS mini should be performed per the instructions of your prescribing physician. One treatment consists of two sTMS pulses of magnetic energy over a set period of time. Read the instructions below prior to operating the device. Then, follow the entire procedure as described below. After the initial treatment of two pulses, you may treat again after 24 hours. Consult your physician for additional treatment information.

NOTE: Become familiar with the System and how to use it before you experience a migraine.

Preparing for Treatment

To treat the symptoms of a migraine headache, use the sTMS mini at the first sign of migraine pain with aura. Consult your doctor about your specific condition and the best timing of your sTMS treatment.



- **Precaution:** Keep the System away from other electronic devices that depend-on (receive) or radiate (transmit) radio frequency energy, when it is powered on.
- The operation of the System may be impaired when operated near home devices such as wireless network routers, mobile phones, cordless telephones and their base stations and walkie-talkies. Keep the sTMS mini device at least **2 feet (0.6 meter)** from these devices when it is powered on and in use.
- The System emits a strong magnetic pulse that may interfere with the operation of common home electronic devices such as radios, televisions, wireless network routers, mobile phones, cordless telephones and their base stations and walkie-talkies, if they are not installed and used in accordance with the manufacturer's instructions. There is no guarantee that interference will not occur in a particular installation. If the System causes interference with other devices, try to correct the matter by:
 - Reorienting or relocating the device receiving the interference.
 - Increase the separation distance between the System and the device.
 - Connect the System to an AC outlet on a circuit different from that to which the other device is connected.

Use the System in a comfortable, seated position. Remove the System from its storage location.

- ▲ **WARNING:** Inspect the System for any signs of damage before use. Do not use if it is cracked or wet. If you suspect damage to the device, call eNeura at +1 855.366.8355 option 1 for assistance.

The System needs to be in direct contact with the back of your head to work properly. Before treatment, remove any hat, head covering, or hairpiece that covers the back of your head and undo any braids, ponytails or buns.

- ▲ **WARNING:** Remove any personal medical devices such as insulin pumps or other medical pumps and bone growth stimulators.

- Press the power button 
- Watch the LED track light progress around the power button: 
- It takes 30-60 seconds to prepare the System for treatment.
- As the device prepares for treatment, each segment will light up to indicate progress.
- When the system is ready, the device lights up all 6 segments and sounds an audio tone: 
- Once the System is ready, you have 45 seconds to position the device and deliver treatment.

- ▲ **WARNING:** Stay at least **2 feet (0.6 meter)** from others when using the sTMS mini. This device could be harmful to anyone with an electronic implant such as a pacemaker.
- ▲ Remove any personal medical devices such as insulin pumps, other medicinal pumps, bone growth stimulators, Transcutaneous Electrical Nerve Stimulator (TENS) devices and hearing aids.
- ▲ Do not use the System if you use a wearable cardioverter defibrillator (WCD).
- ▲ The System should not be used while driving, operating machinery or during any activity in which involuntary muscle contractions may put you at risk of injury.
- ▲ Risk of electrical shock: Do not allow the System or power cords to get wet. Quickly wipe up spills on or near the device. Do not use the device in or near water. For example, do not use while in the bathtub or shower, in the rain or while standing in water or on a wet surface.
- ▲ Do not operate the System in or near an area where explosive gases are being used or have been used. Do not operate near diesel fuel, gasoline or natural gas.
- ▲ Do not operate the System in or near the presence of a **FLAMMABLE ANESTHETIC MIXTURE WITH AIR** or with **OXYGEN** or **NITROUS OXIDE**.
- ▲ Do not use the System if the cause of your headache is illness, trauma or excess medication. Consult your doctor if you are unsure.
- ▲ Do not use the System if you have suspected or diagnosed epilepsy. Consult your doctor before using the System if a family member has epilepsy. Consult your doctor if you have had a head trauma, head injury or take any medication such as tricyclic antidepressants, neuroleptic agents or other drugs that lower the seizure threshold.
- ▲ Do not use the System if you have a history of stroke.
- ▲ Caution should be used for patients with suspected or diagnosed heart problems.

- **Precaution:** Keep the sTMS mini away from metal or conductive objects, medical devices and magnetic media when it is powered on.
- When activated, the System emits a strong magnetic pulse and may interfere with other metal, electronic or magnetic products within **2 feet (0.6 meter)**. A person with a hearing aid or cochlear implant may hear a click when the System is activated.
- The operation of the sTMS mini System may be impaired when operated near home devices such as wireless network routers, mobile phones, cordless tele- phones and their base stations, and walkie-talkies. Keep the sTMS mini device at least **2 feet (0.6 meter)** from these devices when it is powered on and being used.
 - Move credit cards, audio/video tapes, computers, computer disks, flash memory sticks, cell phones, personal digital assistants (PDAs), MP3 players, headphones, digital cameras, portable glucose meters and other electronic devices or electronic storage media more than **2 feet (0.6 meter)** away from the System.
- Remove all metal objects from your head, face, neck, arms and hands. Remove eyeglasses, hearing aids, removable metallic orthodontic appliances, hair clips and earphones and move them more than **2 feet (0.6 meter)** away from the System.
- Remove any loose metal objects from your shirt pockets such as keys, coins, clips, pens and mechanical pencils and move them more than **2 feet (0.6 meter)** away from the System.

Positioning the Device

- ❑ With the sTMS mini in front of you: The treatment buttons should be facing up and the accessory door should be facing away from you. Place your hands on the sides of the device with your thumbs on the treatment buttons.
- ❑ Lift the System over your head. The device should be placed so that it comfortably and naturally cradles the base of your skull. Hold it firmly against your head.
- ❑ The curved surface positions the device to fit comfortably against the head and optimize pulse delivery.

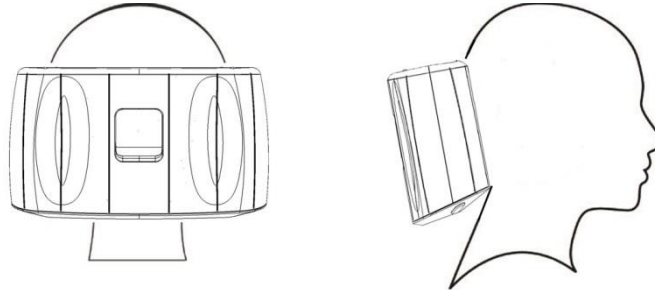

- ▲ **WARNING:** Transcranial magnetic stimulation should only be applied to the back of the head as described in the “Positioning the Device” section of this manual.
- ▲ Do not stimulate over the front of the neck or mouth. Severe spasm of the laryngeal and pharyngeal muscles may occur. Contractions may be strong enough to close the airway or cause difficulty breathing.
- ▲ Do not stimulate over the side of the neck. Stimulation of the carotid sinus nerves, particularly in patients with a known sensitivity to the carotid sinus reflex, could result in a sudden drop in blood pressure, slowing of the heart or loss of consciousness.
- ▲ Do not stimulate the chest or back. Electrical current into the heart may cause cardiac arrhythmias.

NOTE: If the device detects an error when it is on, a symbol is displayed. See the “Understanding System Display Messages” and “Troubleshooting” sections of this manual.

NOTE: The System is a handheld device that comes in direct contact with skin. The housing of the device is made of polycarbonate, a plastic common in consumer medical products, and poses no handling risk.

Delivering the Treatment

NOTE: Two hands are needed to stabilize the device, but only one treatment button needs to be activated to deliver treatment.

NOTE: The device shuts itself off if treatment is not delivered within 45 seconds. Press the power button to turn the device back on and restart the treatment procedure.

- Once the device is in place and your thumbs are on the treatment switches, press one or both switches and hold for at least 2 seconds.
- The device emits a soft, audible click as the treatment is delivered.
- After you have successfully delivered the first pulse, remove the device from your head.
- The LED light on the POWER button softly pulses to show that treatment is completed. The device is now ready for another pulse. You may select to treat again by pressing the power button. Otherwise the device will shut off after 10 seconds.
- Repeat the subsequent procedures from page 14, Positioning the Device.
- After delivering the second pulse, the device will shut off after 10 seconds.
- Delivery of several pulses in a row may cause the device's surface temperature to exceed 105.8° F (41° C). The surface may get as warm as 118.4° F (48° C). Let the device cool for 15 minutes. Try again.

Renewing Your Prescription

NOTE: The System is intended for use under the care of a doctor. For more information on renewing your prescription, please contact eNeura Customer Care. An active prescription is required.

NOTE: The System only delivers sTMS treatments if the Micro SIM Rx card has been properly inserted and has not expired.



- The Micro SIM Rx card from your prescription card must be installed to activate the device to deliver sTMS treatments.
- Your Micro SIM Rx card from your first prescription card comes preinstalled in the device.
- The device will display an ORANGE warning light when your Micro SIM Rx card is about to expire: **Rx** Renew your prescription promptly.
- After renewing your prescription, you will receive a prescription card containing a new Micro SIM Rx card.

Replacing the Micro SIM Rx card

- Open the accessory door on the back of the device.

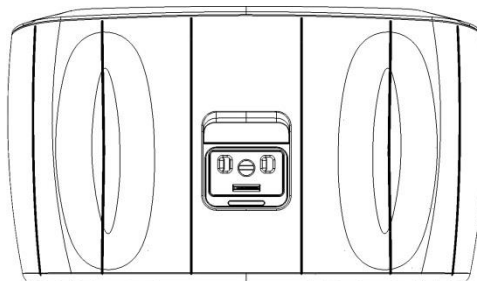
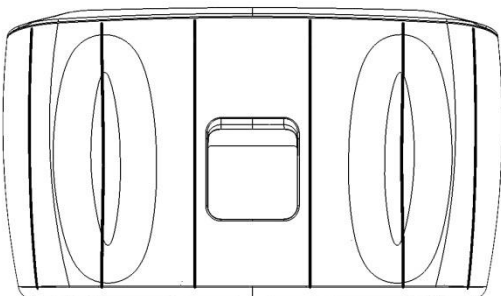

- Push on the edge of the Micro SIM Rx card. It pops out about 3 mm (1/8 inch).

- Pull the Micro SIM Rx card out with your fingers. This expired Micro SIM Rx card is of no value.
- Dispose as eWaste or recycle by appropriate methods.

▲ WARNING: The Micro SIM Rx card may be swallowed and present a choking hazard for infants or small children if it is ejected from the SIM card port and left loose and unattended.

- Remove your new Micro SIM Rx card (the cut-out portion) from the prescription card by pressing down firmly on the Micro SIM Rx card. Check that it is the same shape as shown below. Remove any excess plastic.

Micro SIM Rx card

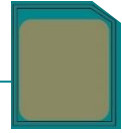

- Insert the Micro SIM Rx card with the gold side up and the edge with the blunt corner pointing into the Micro SIM Rx card port.
Push the Micro SIM Rx card until it is flush with the opening and snaps into place. Close the accessory door.

Additional Information

Battery Capacity Indicator



Your sTMS mini has rechargeable batteries. The battery capacity indicator on your device shows how much charge is remaining in the battery. eNeura recommends that you keep your device's battery charged so that it is always ready when you need it. Typically, a fully charged battery can deliver 18 treatments. Your battery pack life is roughly a minimum of 100 charge cycles.

Recharging the Battery

- To recharge your battery, push the round plug on the battery charger into the battery charger port on the back of the device. Plug the battery charger into a standard wall outlet.

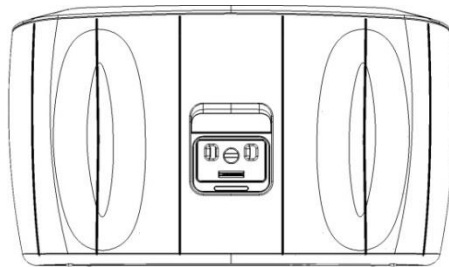

- The AC adapter and battery capacity indicators are lit while the device is on and the battery is charging. Treatment while recharging is disabled for safety. To use the device for treatment, unplug the battery charger and proceed with your treatment.

▲ WARNING: The battery charger cable may present a strangulation or trip hazard if the System is left unattended around infants and small children. Recharge the System's battery in a safe location, away from foot traffic and children. Store the battery charger in a safe place when not in use.

Locking the System

- The System lock switch is located beneath the Accessory door.
- The System lock may be controlled by sliding the switch to the desired position (ON or OFF).
- When the System is locked, the device will prevent others from using it by disabling treatment functionality.

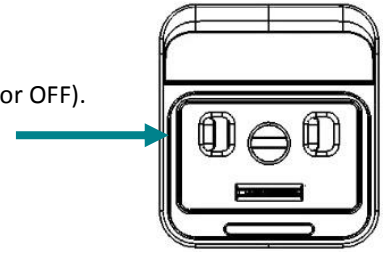

Adjusting the Audible Tone

- The System sounds an audible tone when the device is ready to deliver a treatment.
- The switch to control the audible tone is located beneath the Accessory door.
- Slide the switch to the desired position (ON or OFF).

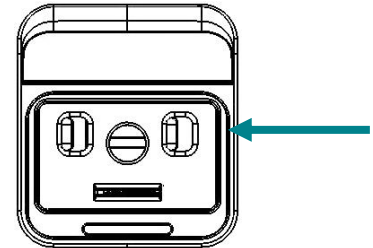

Travel

- Your sTMS mini may travel with you. Pack it securely to avoid damage during travel. Before using the unit after traveling, check it for any damage to ensure it appears to be working correctly before you use it.
- For international travel, use either the correct international plug adapter or contact eNeura to purchase the correct plug for your battery charger. Only use the AC adapter that was provided with the System.

Caring For Your sTMS mini

Inspect your device regularly

- Before using your sTMS mini always check to make sure your device is in good working order. If you notice damage to the exterior of the device or rattling when you shake the device DO NOT USE the device and contact your eNeura representative for a replacement.

Rechargeable Battery

- The rechargeable battery in the sTMS mini is in a sealed compartment and may only be replaced by a trained service technician. If the battery fails to recharge, please contact Customer Care to arrange for a device exchange.

Cleaning Procedure

- eNeura recommends cleaning the sTMS mini every three months, similar to the way you would clean a telephone handset. It may be necessary to clean the System more often if it becomes dirty or sticky. It may be cleaned as many times as needed.
- Only the external surfaces of the System may be cleaned. Wipe dust and lint away with a dry cloth. Take care not to drip or spray liquid directly onto your device or get liquid into any of the ports, the buttons or the display. Dampen a soft cloth in water premixed with a mild detergent or an alcohol-based, hospital-grade, hand-disinfecting solution. Wring out any excess liquid, and then wipe the device. Immediately dry the device with a soft dry cloth to make sure that no liquid remains on the surface.
- Do not use any spray cleaners because fluid should not enter openings. Do not use detergents or other cleaning solutions to clean the display.

- **Precaution:** Disconnect the sTMS mini from the battery charger prior to cleaning. NEVER immerse the System. Do NOT drip or splash any liquid on the device. Contact eNeura if the device gets wet. Do not attempt to sterilize the System.

Understanding System Display Messages

If your device displays one of the following images, please take the steps listed to clear the message.



Battery charge is full



Battery charge is low

- The rechargeable battery charge is low. There is only enough power to deliver approximately 10 treatments so charge the battery at your earliest convenience.
- Charge the battery for at least 15 minutes. To fully charge the battery, allow the device to charge for about 4 hours.
- If the problem persists, check that only the eNeura battery charger (DWG-0505) is in use. Check that the battery icon on the display is lit to show it is charging.
- If the problem persists, contact eNeura or your local Agent for help.



Prescription expires in less than 15 days

- If the Rx symbol is orange, please contact eNeura or your local Representative to order a new prescription card. An active prescription is required.



Valid treatment card installed

- If the Rx symbol is white, the Micro SIM Rx card installed is valid and active.



Invalid treatment card installed

- If the Rx symbol is orange and blinking, the Micro SIM Rx card installed in the device cannot be read by your device and may be invalid.
- Turn off the device, remove and reinstall the Micro SIM Rx card.
- If the Rx symbol is still orange and blinking, contact eNeura or your local Representative for assistance.



Prescription expired

- The prescription Micro SIM Rx card installed in the device has expired and can no longer be used. Each Micro SIM Rx card is valid for a specific date range based on the prescription issued by your doctor. If you have received a new Micro SIM Rx card, install it in your device.
- If you need a new Micro SIM Rx card, contact eNeura or your local Representative for assistance. An active prescription is required. eNeura can contact your physician if a renewal prescription is required.



Security Lock Enabled

- The security lock is enabled and the device is non-operable. To unlock the device and make the device operable, slide the lock switch to the “off” position.



Device temperature not in operating range

- ❑ The device does not operate when its temperature is below 16°C (60°F) or above 40°C (104°F). Move the device to a more temperate environment, such as inside your home or office, and wait 15 minutes. Try again.

- **Precaution:** Do NOT actively heat or cool your sTMS mini in any way.



Contact eNeura Customer Care

- ❑ If this symbol appears with the Prescription low or expired symbol, contact Customer Care (+1-408-245-6400) to renew or refill your prescription.
- ❑ Otherwise, this symbol means service is needed and the device will not deliver treatment. Contact Customer Care for assistance.



Treatment not allowed (Orange power button)

- ❑ If this symbol appears with the Prescription Expired, Device Locked, Battery Low, Charger Connected or other symbols, , then the device will prohibit treatment until the other system messages are cleared. Clear these symbols. Restart the device.
- ❑ Contact Customer Care for help if other symbols do not appear with the Orange power button.



Troubleshooting

None of the device indicator lights are on

- ❑ The device may not be powered on. Press the power button for at least one second.
- ❑ The battery may be completely discharged. Plug in the battery charger to charge the battery for at least 15 minutes. Be sure that only the eNeura battery charger (DWG-0505) is being used. When you plug in the battery charger, the display should light. Check that the battery icon on the display is lit to indicate that the battery is charging.
- ❑ If the problem persists, contact eNeura or your local Representative for assistance.

- ▲ **WARNING:** There are no user serviceable parts inside. Do not attempt to open the device, as it could expose user to hazardous voltages. Do not try to modify the unit in any way.

The device is charging correctly, but I can't make it deliver a treatment.

- ❑ Check the power button indicator  to confirm the device is ready for treatment.
- ❑ Check the lock switch to make certain it is not locked.
- ❑ Disconnect the battery charger if it is connected to the device.
- ❑ The Micro SIM Rx card may not be installed or may have expired. Check the  indicator and install a current Micro SIM Rx card if required.

- ❑ The device may be too warm or too cold. Check the  indicator. The device does not operate when its temperature is below 15°C (60°F) or above 40°C (104°F). Move the device to a normal indoor environment and wait 15 minutes before trying again.

- **Precaution: Do NOT actively heat or cool your sTMS mini in any way.**

Service

- ❑ For questions about your sTMS mini, please call or email Customer Care at eNeura.
- ❑ Please have your device available when calling eNeura Customer Care.
- ❑ When the System is no longer usable, return it to eNeura or your local Representative. Do not dispose of the device. For questions, contact eNeura or your local Representative for assistance.

- **Precaution: Only authorized service personnel should service or repair components of the sTMS mini. There are no user serviceable parts. Improper service, repair or modifications performed by unauthorized personnel may pose a hazard and void the warranty. Do not heat, incinerate or dispose of the device.**

Return Goods Policy

- ❑ Contact eNeura or your local Representative for information on product returns and return authorization. Contact information is available at the beginning of this manual and on the last page.

NOTE: Do not discard the box or packing materials. They will be required if you need to return this product.

Technical Specifications

Weight:	3.2 lb (1.4 kg)
Size:	8.8 in long x 5.1 in wide x 2.7 in deep (22.4 cm long x 13 cm wide x 6.9 cm deep)
Electrical Power	Internally powered (Rechargeable battery)
Battery charger:	Input: 100-240V AC, 400 mA (max), 50/60 Hz Output: 12V DC, 1.5A
Plug Type:	Class II (ungrounded 2-prong plug)
Rechargeable Battery:	7.2V, 2150 mAh, 15.48 Wh lithium ion battery Typical battery life is 100 charge cycles (minimum)
Magnetic Pulse Output	0.9 Tesla (nominal) at 1 cm from the center of curved surface of the sTMS mini per treatment

Operating Environment

- ❑ The sTMS mini is a battery-operated device.
- ❑ The sTMS mini requires a regular home or office electrical outlet for proper battery recharging.
- ❑ The sTMS mini operates best in typical household and office environments where the temperature is 15°C to 40°C (60°F to 104°F); relative humidity range of 10% to 90%, non-condensing; an atmospheric pressure range of 700 hPa to 1013 hPa; operating altitude of less than or equal to 3000m.
- ❑ The sTMS mini is not affected by exposure to dust or lint normally found in household and office environments.
- ❑ The sTMS mini and its accessories may be exposed to sunlight for a few days duration, but prolonged or repeated exposure to direct sunlight is not recommended.
- ❑ It is recommended that a cold device (below 60°F or 15°C) be allowed to warm to room temperature for at least 15 minutes prior to use. Similarly, it is recommended that a hot device (above 104°F or 40°C) be allowed to cool for at least 15 minutes prior to use.
- ❑ The sTMS mini is suitable for home use, and complies with IEC 60601-1-11:2015.

- **Precaution:** Do NOT actively heat or cool your sTMS mini in any way.

Storage Environment

- ❑ The sTMS mini may be stored at -40°C to 60°C (-40°F to 140°F) with a relative humidity of up to 90% non-condensing and an atmospheric pressure range of 700 hPa to 1060 hPa and storage altitude of less than or equal to 3000m.
- ❑ Keep your sTMS mini dry during operation, storage and transport. When not in use, store the sTMS to protect it from household dust and lint, accidental spills or exposure to the elements (rain, dust, insects, vermin, prolonged direct sunlight, etc).
- ❑ During extended storage periods, it is recommended that the battery be periodically recharged every 6 months, so that the device will be available for use when needed.

Industry Standard Classification

(IEC 60601-1)	Classification
Type of Electric Shock Protection (sTMS mini) (Battery Charger, external)	Internally powered Class II
Degree of Electric Shock Protection	Type B applied part
Degree of Protection Against Harmful Ingress of Liquids and Particulates	IP22
Safety in the Presence of Flammable Atmosphere	Not suitable for use in flammable environment
Mode of Operation	Short-time operation – individual 1ms pulses
EMC	Class B
Service Life (sTMS mini device, AC Adapter and Rx SIM Card)	1800 treatments

REACH and Warning Statement

Thresholds and Substances of Very High Concern (SVHCs) are defined in Article 7 and 57 of Regulation (EC) No 1907/2006 (REACH Regulation). This article contains a substance on the Candidate List in a concentration above 0.1% (w/w), namely: 4-Nonylphenol, branched and linear -substances with a linear and/or branched alkyl chain with a carbon number of 9 covalently bound in position 4 to phenol, covering also UVCB- and well-defined substances which include any of the individual isomers or a combination thereof. This substance is completely enclosed in the device, and does not pose a safety concern during use.

EMC Compliance and Warning Statement

☐ IEC 60601-1-2: 2014

This equipment has been tested and found to comply with the limits for a Class B digital device, pursuant to part 15 of the FCC Rules and with the limits of the standard for medical devices, IEC 60601-1-2, suitable for use in all environments including domestic. The unit also complies with the requirements of EN 60601-1-2, providing the presumption of compliance to the European Union's Medical Device Directive 2007/42/EC. The limits are designed to provide reasonable protection against harmful interference in a typical medical installation. This equipment generates, uses, and can radiate radio-frequency energy, (such as wireless home networks, mobile phones, cordless telephones and their base stations, and walkie-talkies), and, if not installed and used in accordance with the manufacturer's instructions, may cause harmful interference to other devices in the vicinity. Use of this equipment adjacent to or stacked with other equipment should be avoided because it could result in improper operation. Portable RF communications equipment (including peripherals such as antenna cables and external antennas) should be used no closer than 30 cm (12 inches) to any part of the sTMS mini, including cables specified by the manufacturer. Otherwise, degradation of the performance of this equipment could result. However, there is no guarantee that interference will not occur in a particular installation. If this equipment causes interference with other devices, which may be determined by turning the equipment off and on, the user is encouraged to try to correct the interference by one or more of the following measures:

- Reorient or relocate the device receiving the interference.
- Increase the separation between the equipment.
- Connect the equipment into an outlet on a circuit different from that to which the other device(s) are connected.
- Consult the manufacturer or field service technician for help.

EMC Guidance

In accordance with Clause 4.3 of IEC 60601-1, the Essential Performance of the sTMS Mini is to not deliver a pulse above 0.95T.

EMC interference from other equipment may disrupt normal operation of the sTMS Mini and may impede the delivery of the 0.9T magnetic pulse to the patient's head. If other equipment interferes with normal sTMS Mini operation, which may be determined by turning the equipment off and on, the user is encouraged to try to correct the interference by one or more of the following measures:

- Reorient or relocate the sTMS Mini device away from the equipment.
- Increase the separation between the sTMS Mini and the equipment.
- Connect the equipment into an outlet on a circuit different from that to which the sTMS Mini is connected.
- Consult eNeura Customer Service for assistance.

Guidance and Manufacturer's Declaration - Emissions

The **DWG-0500** is intended for use in the electromagnetic environment specified below. The customer or user of the **DWG-0500** should ensure that it is used in such an environment.

Emissions Test	Compliance	Electromagnetic Environment – Guidance
RF Emissions CISPR 11	Group 1	The DWG-0500 uses RF energy only for its internal function. Therefore, its RF emissions are very low and are not likely to cause any interference in nearby electronic equipment.
RF Emissions CISPR 11	Class B	The DWG-0500 is suitable for use in all establishments, including domestic establishments and those directly connected to the public low-voltage power supply network that supplies buildings used for domestic purposes.
Harmonics EN 61000-3-2	Class A	
Flicker EN 61000-3-3	Complies	

Guidance and Manufacturer's Declaration – Immunity

The **DWG-0500** is intended for use in the electromagnetic environment specified below. The customer or user of the **DWG-0500** should ensure that it is used in such an environment.

Immunity Test	IEC 60601 Test Level	Compliance Level	Electromagnetic Environment – Guidance
ESD IEC 61000-4-2	±8kV Contact ±15kV Air	±8kV Contact ±15kV Air	Floors should be wood, concrete or ceramic tile. If floors are synthetic, the r/h should be at least 30%
EFT IEC 61000-4-4	±2kV Mains ±1kV I/Os	±2kV Mains	Mains power quality should be that of a typical domestic environment.
Surge IEC 61000-4-5	±1kV Differential ±2kV Common	±1kV Differential	Mains power quality should be that of a domestic environment.
Voltage Dips/Dropout IEC 61000-4-11	>95% Dip for 0.5 Cycle >95% Dip for 1 Cycle 30% Dip for 25/30 Cycles >95% Dip for 250/300 Cycles	>95% Dip for 0.5 Cycle >95% Dip for 1 Cycle 30% Dip for 25/30 Cycles >95% Dip for 250/300 Cycles	Mains power quality should be that of a typical domestic environment. If the user of the DWG-0500 requires continued operation during power mains interruptions, it is recommended that the DWG-0500 be powered from an uninterruptible power supply or battery.
Power Frequency 50/60Hz Magnetic Field IEC 61000-4-8	30A/m	30A/m	Power frequency magnetic fields should be that of a typical domestic environment.

EMC Guidance (continued)

Guidance and Manufacturer's Declaration – Immunity

The **DWG-0500** is intended for use in the electromagnetic environment specified below. The customer or user of the **DWG-0500** should ensure that it is used in such an environment.

Immunity Test	IEC 60601 Test Level	Compliance Level	Electromagnetic Environment – Guidance
Conducted RF IEC 61000-4-6	3 V 0.15 MHz-80 MHz 6 V in ISM and amateur radio bands between 0.15 MHz and 80 MHz 80 % AM at 1 kHz	3 V 0.15 MHz-80 MHz 6 V in ISM and amateur radio bands between 0.15 MHz and 80 MHz 80 % AM at 1 kHz	HOME HEALTHCARE ENVIRONMENT
Radiated RF IEC 61000-4-3	10 V/m 80 MHz – 2.7 GHz 80 % AM at 1 kHz	10 V/m 80 MHz – 2.7 GHz 80 % AM at 1 kHz	HOME HEALTHCARE ENVIRONMENT

Guidance and Manufacturer's Declaration – Immunity

The **DWG-0500** is intended for use in the electromagnetic environment specified below. The customer or user of the **DWG-0500** should ensure that it is used in such an environment.

Test Frequency	Band ¹	Service ¹	Modulation ²	Maximum Power	Distance	Immunity Test Level
MHz	MHz			W	Meters	(V/m)
385	380 - 390	TETRA 400	Pulse modulation ² 18 Hz	1.8	0.3	27
450	430 - 470	GMRS 460, FRS 460	FM ³ ± 5 kHz deviation 1 kHz sine	2	0.3	28
710 745 780	704 - 787	LTE Band 13, 17	Pulse modulation ² 217 Hz	0.2	0.3	9
810 870 930	800 - 960	GSM 800/900, TETRA 800, iDEN 820, CDMA 850, LTE Band 5	Pulse modulation ² 18 Hz	2	0.3	28
1720 1845 1970	1700 - 1900	GSM 1800; CDMA 1900; GSM 1900; DECT; LTE Band 1, 3, 4, 25; UMTS	Pulse modulation ² 217 Hz	2	0.3	28
2450	2400 - 2570	Bluetooth, WLAN, 802.11 b/g/n, RFID 2450, LTE Band 7	Pulse modulation ² 217 Hz	2	0.3	28
5240 5500 5785	5100 - 5800	WLAN 802.11a/n	Pulse modulation ² 217 Hz	0.2	0.3	9

NOTE If necessary to achieve the IMMUNITY TEST LEVEL, the distance between the transmitting antenna and the ME EQUIPMENT or ME SYSTEM may be reduced to 1 m. The 1 m test distance is permitted by IEC 61000-4-3.

¹ For some services, only the uplink frequencies are included.

² The carrier shall be modulated using a 50 % duty cycle square wave signal.

³ As an alternative to FM modulation, 50 % pulse modulation at 18 Hz may be used because while it does not represent actual modulation, it would be worst case.

Table 6 – Recommended separation distances between portable and mobile RF communications equipment and the ME EQUIPMENT or ME SYSTEM – for ME EQUIPMENT and ME SYSTEMS that are not LIFE-SUPPORTING
(from IEC 60601-1-2 © 2014)

Recommended separation distances between
portable and mobile RF communications equipment and the sTMS Mini

The sTMS Mini is intended for use in an electromagnetic environment in which radiated RF disturbances are controlled. The customer or the user of the sTMS Mini can help prevent electromagnetic interference by maintaining a minimum distance between portable and mobile RF communications equipment (transmitters) and the sTMS Mini as recommended below, according to the maximum output power of the communications equipment.

Rated maximum output power of transmitter W	Separation distance according to frequency of transmitted m		
	1150 kHz to 80 MHz d=1.2VP	80 MHz to 800 MHz d=1.2VP	800 MHz to 2.5 GHz d=2.3VP
0.01	0.12	0.12	.23
0.1	0.38	.38	.74
1	1.2	1.2	2.3
10	3.8	3.8	7.4
100	12	12	23

For transmitters rated at a maximum output power not listed above, the recommended separation distance d in meters (m) can be estimated using the equation applicable to the frequency of the transmitter, where P is the maximum output power rating of the transmitter in watts (W) according to the transmitter manufacturer.

NOTE 1 At 80 MHz and 800 MHz, the separation distance for the higher frequency range applies.























NOTE 2 These guidelines may not apply in all situations. Electromagnetic propagation is affected by absorption and reflection from structures, objects and people.

The device and the method of use that comprise the eNeura sTMS mini™ are protected by U.S. Patents 6,402,678, 7,294,101, 7,494,458 and 7,601,116; by European Patents 1 307 260 B1 and 1 977 787 B1; and by Canadian Patent 2423840. Additional patents are pending.

Glossary of Abbreviations

CE Mark	CE mark certifies that a product has met EU consumer safety, health or environmental requirements.
Intertek ETL	Intertek Mark certification marks indicate that this product has been tested to a U.S. standard and it meets the requirements of an applicable ETL standard or another recognized document used as a basis for certification. Conforms to AAMI STD ES60601-1, IEC STDS 60601-1-6, 60601-1, 60601-1-11, 62304 and 62366
EMC	Electromagnetic Compatibility
IEC	International Electro-technical Commission
SN	Serial Number
TMS	Transcranial Magnetic Stimulation, which is a method of using a brief pulse of magnetic energy to stimulate nerves in the brain

Key to Symbols

CE Mark		Attention: See Instructions for Use	
Intertek Mark	ETL CLASSIFIED  Intertek 5003910	Risk of strong magnetic field	
Protection against falling liquids		Warning, electricity	
Type BF Applied part		Keep Dry	
Caution: Federal law (US) restricts this device to sale by or on the order of a physician	Rx Only	Federal Communications Commission Class B – certified for home use	
Warning		Authorized representative in European Community	
Temperature limitation		EMC non-ionizing radiation	
Humidity limitation		Smart Card status	
Contact eNeura Customer Care		Power button On/Off	
Treatment not allowed		Preparing for Treatment	
Ready for Treatment		Lock switch enabled	
AC Adapter connected		Rechargeable Battery capacity level	

Medical Device Reporting

- ❑ Any potential adverse incident involving eNeura products should be reported immediately by calling your local Representative or Customer Care at eNeura.
Users and physicians may also report adverse events to FDA through MedWatch at 1-800-332-1088 or at <https://www.fda.gov/safety/medwatch>.

Warranty and Limitation of Liability

- ❑ eNeura Inc. warrants that the product when delivered is free from defect in materials and workmanship and conforms to the manufacturer's product specifications. eNeura shall not be liable for any incidental or consequential loss, damage, or expense, directly or indirectly arising from the use of, or inability to use, its product.
- ❑ THE FOREGOING WARRANTY IS IN LIEU OF AND EXCLUDES ALL OTHER WARRANTIES, WHETHER EXPRESSED OR IMPLIED, ARISING BY OPERATION OF LAW OR OTHERWISE, INCLUDING ANY IMPLIED WARRANTIES OF MERCHANTABILITY OR FITNESS FOR A PARTICULAR PURPOSE.
- ❑ eNeura does not assume, nor authorizes any person to assume for it, any other additional liability or responsibility with respect to this product other than as set forth in writing herein.

Customer Care Contact Information



Manufactured by: eNeura Inc.

715 North Pastoria Avenue
Sunnyvale, CA 94085 USA

eNeura Inc.

715 North Pastoria
Sunnyvale, CA 94085

Tel: +1 855.366.8355

Fax: +1 877.874.9584

www.eNeura.com

info@eNeura.com

customercare@eNeura.com

eNeura (UK) Ltd.

6th Floor

One London Wall London EC2Y 5EB

United Kingdom

Tel. +44 (0) 20.3695.4063

Fax: +44 (0) 20.7785.8152

www.eNeura.co.uk

customercare@eneura.co.uk

Authorized Representative

Emergo Europe BV

Prinsessegracht 20

2514 AP The Hague

The Netherlands

Tel: +31 (0) 70.345.8570

Fax: +31 (0) 70.346.7299

www.emergoeurope.eu

Australia Sponsor

Emergo Australia

Level 20, Tower II, Darling Park

201 Sussex Street

Sydney, NSW 2000

Australia

www.emergogroup.com

sTMS mini™

eNeura®

© 2017 eNeura Inc.

eNeura® and sTMS mini™ are trademarks of eNeura Inc.

The device and the method of use that comprise the eNeura sTMS mini are protected by U.S. Patents 6,402,678, 7,294,101, 7,494,458 and 7,601,116; by European Patents 1 307 260 B1 and 1 977 787 B1; and by Canadian Patent 2423840.

Additional patents are pending.

LBL-0103-US Rev D 07/2017